

# YK-PH-POL

Suport pentru fotocelule YK-PHC-102

## DESCRIERE

YK-PH-POL este un suport din metal ce permite instalarea facila a fotocelulelor YK-PHC-102. Reglajul pe inaltime permite alinierea perfecta a receptorului cu transmitatorul. Suportul este prevazut cu o carcasa de protectie pentru fotocelule, ceea ce ofera un plus de siguranta in cazul lovirilor accidentale.

## CARACTERISTICI

- Material: metal
- Culoare: portocaliu
- Fixare: 4 suruburi la sol

## DIMENSIUNI

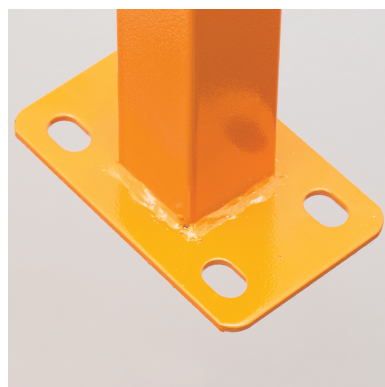
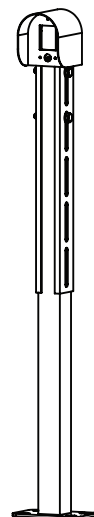
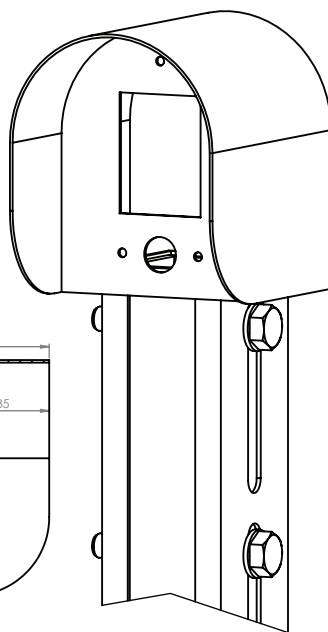
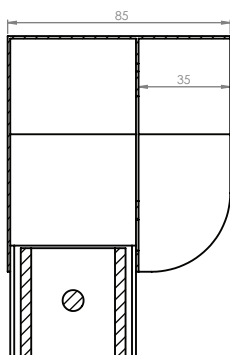
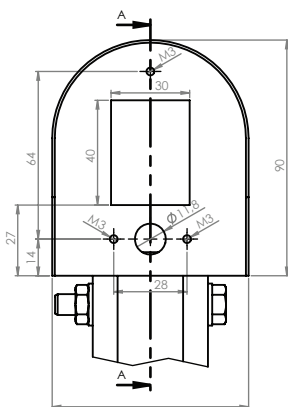
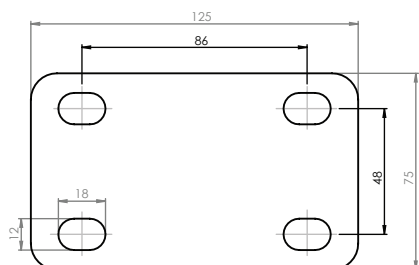
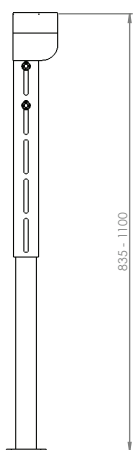
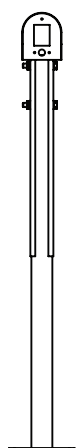

Fisa tehnica

1